



Peterbilt 520EV
Rear Loader/Front Loader
ePTO

Model Year: 2022 – Current
Release Date: 5/2/2022
Part Number: Y53-6176-1B1



The truck body will vary.



This badge is on all battery electric trucks (both doors).

Extrication Diagram



650 V

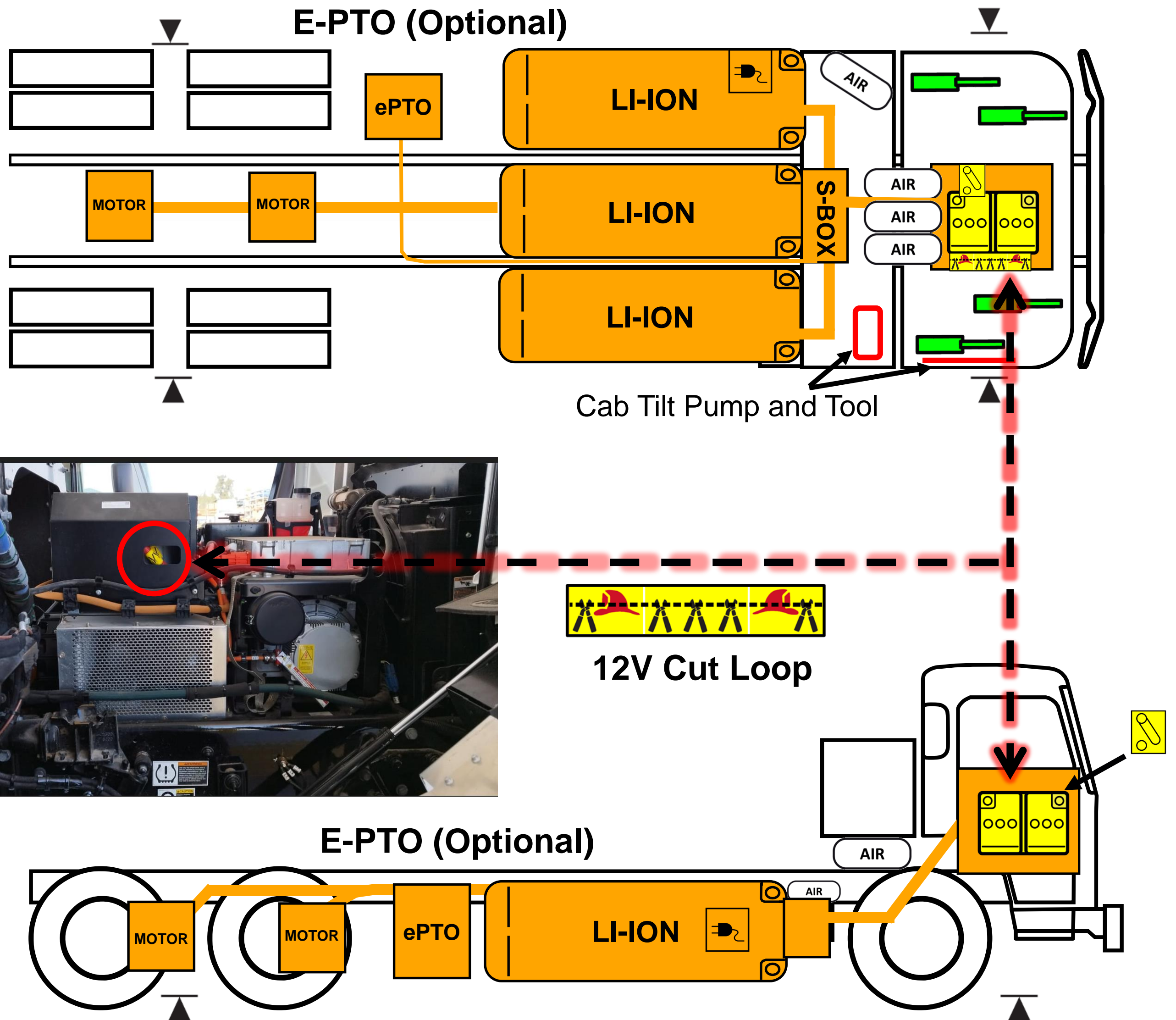

Warning: Check for labels identifying additional High Voltage components added by body builders.

High Voltage Li-Ion Battery Pack	High Voltage Cables	12V Disconnect	Gas Strut
Charger Inlet (Forward or Rear)	High Voltage Region	Low Voltage Batteries	Lift Point
			Compressed Air Tank

1. Identification / Recognition



Warning: Always wear full fire fighter PPE (turnout gear), including a positive pressure self-contained breathing apparatus, when approaching this vehicle.



Battery electric truck badge on the passenger and driver doors

2. Immobilization / Stabilization / Lifting



Warning: Keep all lift equipment at least 12 inches (30 cm) from all high voltage components.



Warning: Vehicle noise may be reduced in some operation modes. Failure to shutdown the truck before immobilization could result in death, severe injury, or property damage.

Complete Section 3 steps if possible before immobilization.

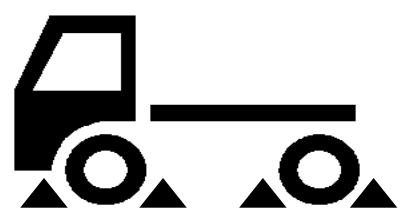

Blocking Wheels

Block all wheels.

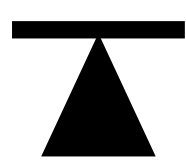

Lifting Truck
(with Jack)

Only use the lift points identified in the extrication diagram with this icon for jacks.



Rotating Truck

Wrap chains around both axles to rotate the truck to an upright stable position.

3. Disable Direct Hazards / Safety Regulations



Warning: Assume all high voltage components are always energized. Do not cut any High Voltage components, including high voltage orange cables.



Warning: Cables between the high voltage battery and the S-box remain energized after the vehicle disable steps (including the 2-minute wait) are completed.



Warning: Call the PACCAR Customer Center for guidance 24/7 before proceeding if any high voltage part damage could have occurred. **Peterbilt Phone #: 1-800-473-8372**

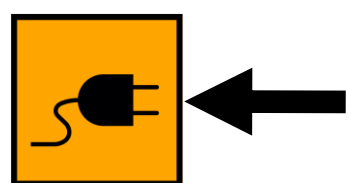

Step 1: Unplug the Charger Cable or Remove Power from the Charger.



Step 2: Remove the Key from Ignition.

Step 3: Engage park brake

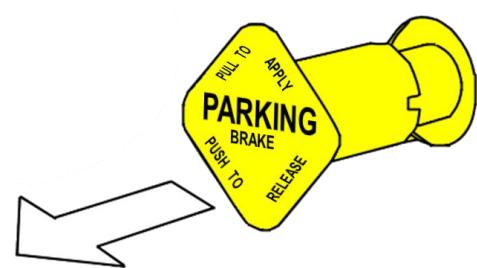

Step 4: Tilt cab forward (see extrication diagram for cab tilt equipment)
Cab tilt instructions are provided on the lift equipment label.

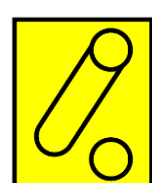

Step 5:
(Primary Step): Turn 12V Disconnect Counterclockwise to OFF Position.



(Alternate Step): Cut a 5-inch (13 cm) segment (2 cuts) from the black cut loop (identified in the Extrication Diagram).



Step 6: Wait 2 Minutes for High Voltage Capacitors to Discharge

5. Stored Energy / Liquids / Gases / Solids



High Voltage (650 V)



Corrosives



Flammable



Health Hazards

6. Fire

Warning: Always wear full fire fighter PPE (turnout gear), including a positive pressure self-contained breathing apparatus.

Warning: Treat fires involving charging stations as energized fires until power to the charger can be shut down.



Use Water to Extinguish Li-ion Fires



Do Not Use Wet Foam



Hazardous to Human Health:

- May cause an allergic skin reaction
- Do not breathe dust, fumes, gas, mist, vapors, or spray.



Flammable Components



Explosion Hazard:

- Explosive gas could accumulate.
- Move truck outside building after extinguishing fire



Corrosives:

- Causes skin burns and eye damage



High Voltage (650 V):

- CAT III (1000 V) rated gloves required for exposed HV parts

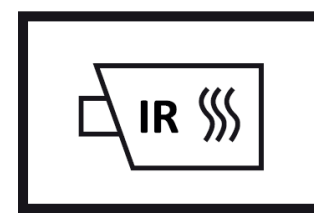

Check Li-ion Battery Pack for Fires with Thermal Infrared Camera (TIC or IR Gun)

7. Water Submersion



- If High Voltage part damage exists (hissing, crackling, bubbles, exposed cables, etc.), call PACCAR Customer Center for guidance (**1-800-473-8372**).
- If no High Voltage part damage exists; remove the truck from the water; let the water drain; follow Section 3 (Disable Direct Hazards); and do not attempt to drive.

8. Towing / Transportation / Storage



- Follow Section 3 (Disable Direct Hazards).
- Use Lift Points in Section 2: Immobilization and the Extrication Diagram.

Towing Method

If high voltage components were damaged or submerged, transport the truck with all wheels on a trailer. Do not attempt to drive. If high voltage components were NOT damaged or submerged, use the cage bolts and remove the axle shafts to tow (propulsion motor not spinning) (Emergency) If the truck must be moved quickly AND no high voltage damage exists, it can be moved at less than 25 mph for no more than 5 minutes.

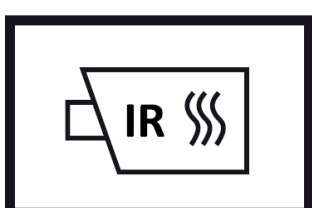

- Store outdoors, 50 feet away from other equipment/structures, and routinely check the battery pack for high temperatures with a Thermal Imaging Camera (TIC or IR Gun).